

Article number: 439500460

Description: Rota-fix shaft-hub connection F460x555
Steel

Note: Self centering. Very high torque

Measures

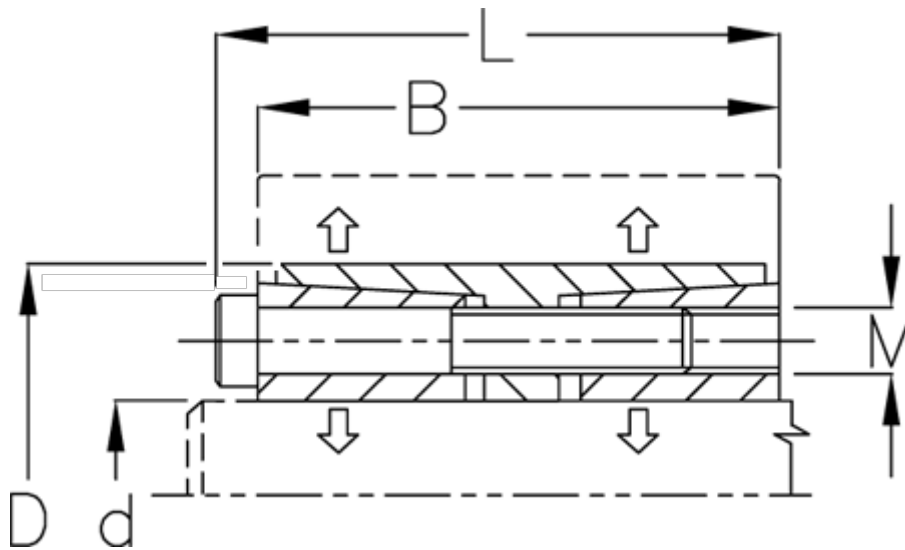

B mm	= 202
d H8 mm	= 460
D mm	= 555
Fit tolerance	= Aksel h8, Nav H8
F kN torque	= 3609.0
L mm	= 224
M mm	= M22
P N/mm ² surface pressure on shaft/hub	= 94

Surface roughness	= R? ? 3.2 µm
T N m torque	= 830000
Ts N m bolt tightening torque	= 930.0